

# Turmdrehkran 90 LD

Tower Crane / Grue à tour / Gru a torre  
Grúa torre / Guindaste de torre

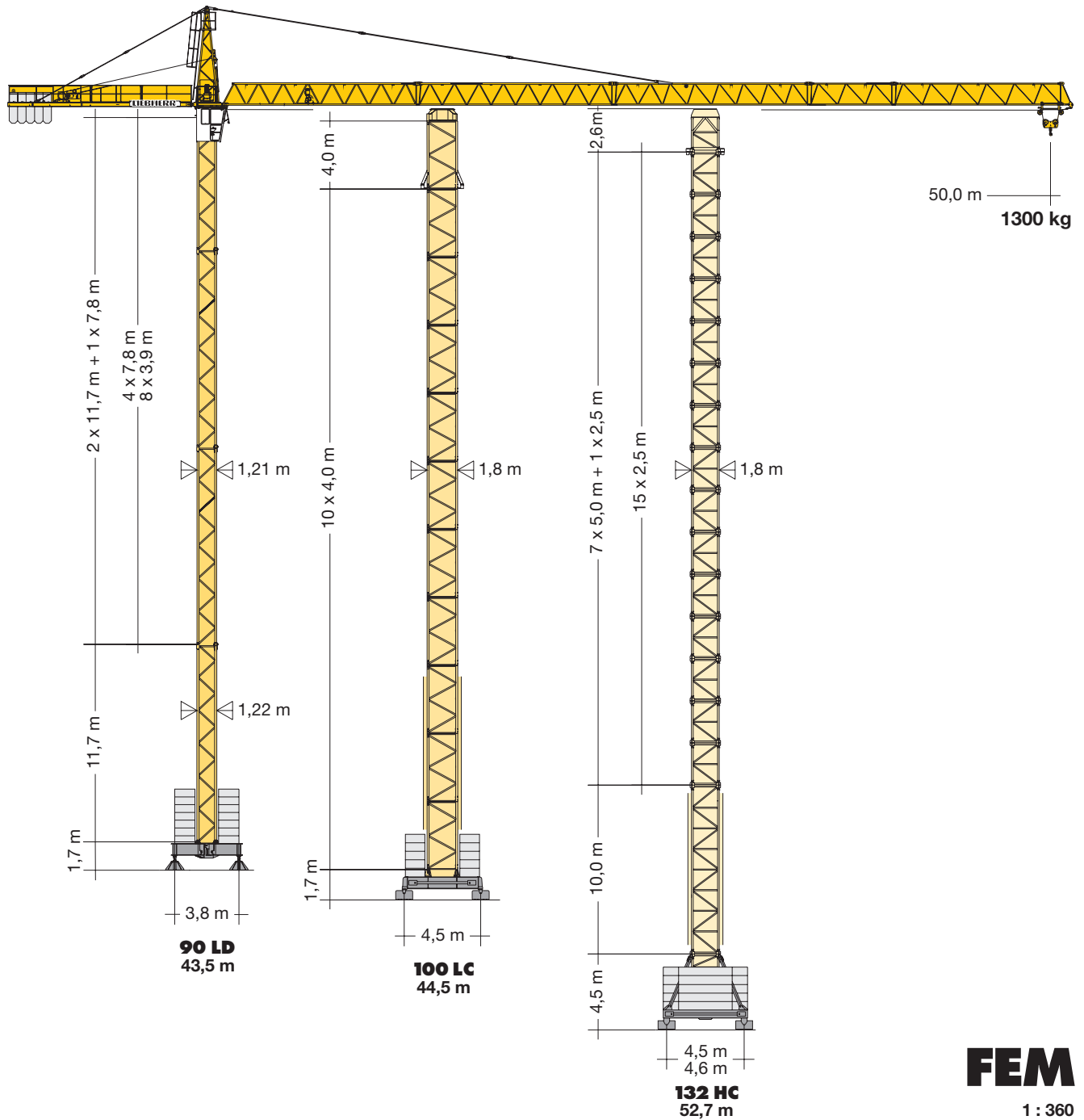

**FEM**

1 : 360

# LIEBHERR

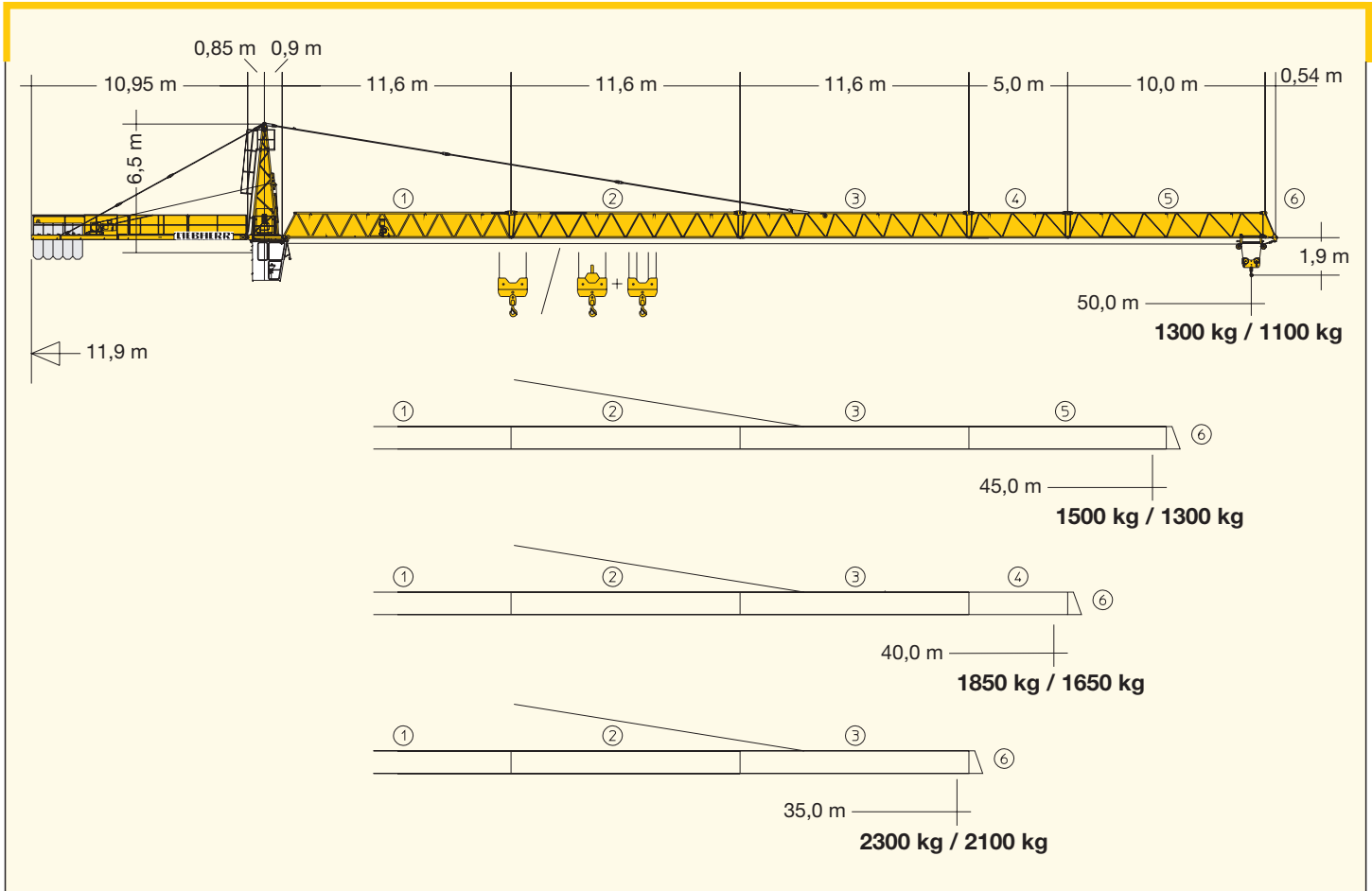

## Gewicht

Weight / Poids / Peso / Peso / Pesos

<b>Zentralballast</b> / Central ballast Lest de base / Zavorra centrale Lastro central / Lastre central	80000 kg		(Ausl. 50 m)	10500 kg		26200 kg
---	----------	--	--------------	----------	--	----------

## Hubhöhe

Hoisting height / Hauteur sous crochet / Altezza di sollevamento / Altura bajo gancho / Altura de montagem

			90 LD			
3,9 m	7,8 m	11,7 m				
8	4		43,3	43,4	42,9	41,9
7	3		39,4	39,5	39,0	38,0
6	3	2	35,5	35,6	35,1	34,1
5	2		31,6	31,7	31,2	30,2
4	2		27,7	27,8	27,3	26,3
3	1	1	23,8	23,9	23,4	22,4
2	1		19,9	20,0	19,5	18,5
1	0		16,0	16,1	15,6	14,6
0	0	0	12,1	12,2	11,7	10,7
			m	m	m	m

# Ausladung und Tragfähigkeit

Radius and capacity / Portée et charge / Sbraccio e portata / Alcances y cargas / Alcance e capacidade de carga

m	r	m/kg	m/kg																		
			12,0	14,0	16,0	18,0	20,0	22,0	24,0	26,0	28,0	30,0	32,0	35,0	40,0	45,0	50,0				
50,0	(r=51,4)	2,4-24,5 3000											3000	2810	2580	2390	2210	1990	1700	1480	1300
45,0	(r=46,4)	2,4-24,8 3000											3000	2850	2620	2420	2240	2020	1730	1500	
40,0	(r=41,4)	2,4-26,3 3000											3000	3000	2790	2580	2400	2160	1850		
35,0	(r=36,4)	2,4-27,7 3000											3000	3000	2970	2740	2550	2300			
m	r	m/kg	m/kg																		
50,0	(r=51,4)	2,4-23,1 3000	2,4-12,8 6000	6000	5420	4640	4040	3570	3180	2870	2600	2380	2180	2010	1790	1500	1280	1100			
45,0	(r=46,4)	2,4-23,4 3000	2,4-13,0 6000	6000	5490	4700	4100	3620	3230	2910	2640	2410	2210	2040	1820	1530	1300				
40,0	(r=41,4)	2,4-24,8 3000	2,4-13,7 6000	6000	5860	5020	4380	3870	3460	3120	2830	2590	2380	2200	1960	1650					
35,0	(r=36,4)	2,4-26,1 3000	2,4-14,4 6000	6000	6000	5330	4660	4120	3680	3320	3020	2760	2540	2350	2100						

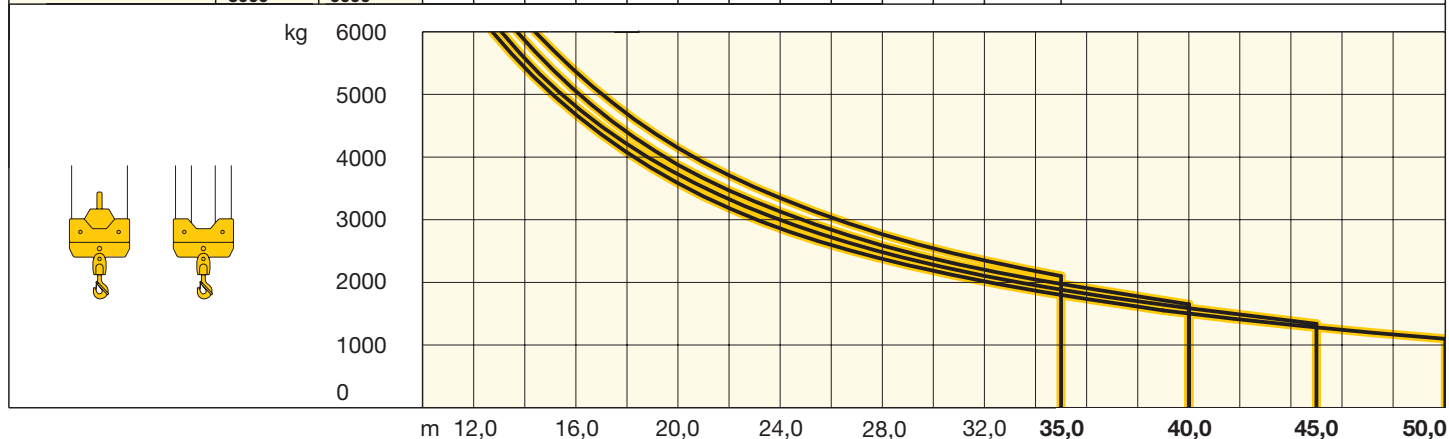





# Hubhöhe











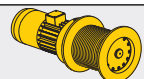
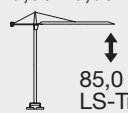



Hoisting height / Hauteur sous crochet / Altezza di sollevamento / Altura bajo gancho / Altura de montagem

100 LC				
4,0 m				
11	44,5*	44,4*	44,1*	43,1*
10	40,5*	40,4*	40,1*	39,1*
9	36,5	36,4	36,1	35,1
8	32,5	32,4	32,1	31,1
7	28,5	28,4	28,1	27,1
6	24,5	24,4	24,1	23,1
5	20,5	20,4	20,1	19,1
4	16,5	16,4	16,1	15,1
3	12,5	12,4	12,1	11,1
2	8,5	8,4	8,1	7,1
1	4,5	4,4	4,1	3,1
	m	m	m	m



\* Weitere Hubhöhen auf Anfrage. / Further hoist heights on request. / Hauteurs sous crochet sur demande. / Altre altezze di sollevamento: su richiesta. / Outras alturas de elevação: conforme ao pedido. / Para alturas bajo gancho superiores, consultar.

	U/min 0 – 0,8 sl./min tr./min	5,0 kW
	9,0 / 30,0 / 60,0 m/min	0,65 / 2,0 / 3,0 kW
	18,0 m/min	4,4 kW
	<b>kVA</b>	22,0 kW 37,0

	<b>Stufe / Step</b> Cran / Marcia Marcha / Marcha	kg	m/min
	3,8 / 18,5 / 22,0 kW 85,0 m LS-Trommel	<b>3 Lagen</b> Layers Couches Strati Camadas Capas	
1		3000	3000 6,0
2		3000	3000 27,0
3		1800	1700 56,0
1		6000	3,0
2		6000	13,5
3		3700	28,0
	149,0 m LS-Trommel	<b>5 Lagen</b> Layers Couches Strati Camadas Capas	
1		3000	3000 6,2
2		3000	3000 28,0
3		1700	1600 58,0
1		6000	3,1
2		6000	14,0
3		3500	29,0





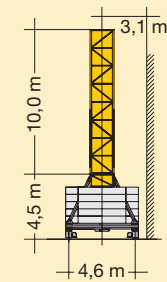
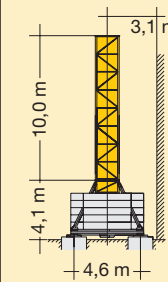
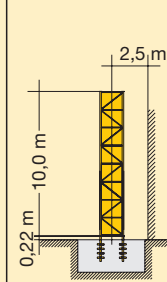
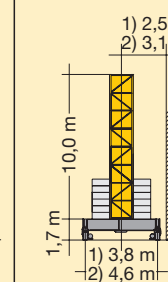
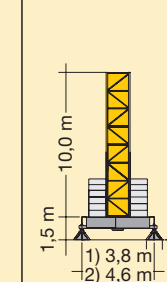
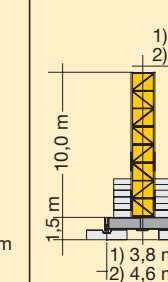





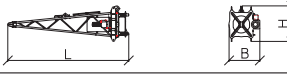
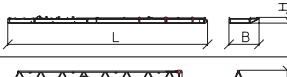

# Hubhöhe

Hoisting height / Hauteur sous crochet / Altezza di sollevamento / Altura bajo gancho / Altura de montagem

		<b>132 HC</b>					
2,5 m	5,0 m						
15		52,7*	52,2*	48,4*	49,9*	49,7*	49,7*
14	7	50,2*	49,7*	45,9*	47,4*	47,2*	47,2*
13		47,7	47,2	43,4	44,9	44,7	44,7
12	6	45,2	44,7	40,9	42,4	42,2	42,2
11		42,7	42,2	38,4	39,9	39,7	39,7
10	5	40,2	39,7	35,9	37,4	37,2	37,2
9		37,7	37,2	33,4	34,9	34,7	34,7
8	4	35,2	34,7	30,9	32,4	32,2	32,2
7		32,7	32,2	28,4	29,9	29,7	29,7
6	3	30,2	29,7	25,9	27,4	27,2	27,2
5		27,7	27,2	23,4	24,9	24,7	24,7
4	2	25,2	24,7	20,9	22,4	22,2	22,2
3		22,7	22,2	18,4	19,9	19,7	19,7
2	1	20,2	19,7	15,9	17,4	17,2	17,2
1		17,7	17,2	13,4	14,9	14,7	14,7
0	0	15,2	14,7	10,9	12,4	12,2	12,2
		m	m	m	m	m	m
							

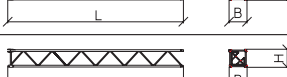

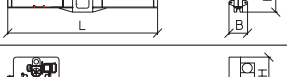
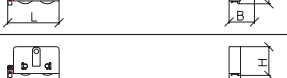
**Weitere Hubhöhen auf Anfrage.** / Further hoist heights on request. / Hauteurs sous crochet sur demande. / Altre altezze di sollevamento: su richiesta. / Outras alturas de elevação: conforme ao pedido. / Para alturas bajo gancho superiores, consultar.

<b>Kranoberteil</b>		<b>Upper part of crane / Partie supérieure de grue / Parte superiore della gru</b>	<b>Parte superior grúa / Parte superior do guindaste</b>	<b>L (m)</b>	<b>B (m)</b>	<b>H (m)</b>	<b>kg*</b>
Pos. Item Rep. Voce Pos. Ref.	Anz. Qty. Qta. Cant.	<b>Kabine + Steuerstand / Cabin + Seat</b> Cabine + fauteuil / Cabina + poltrona Cabine + cadeira / Cabina + butaca		1,87	1,12	2,18	440
1	1						
2	1	<b>Turmspitze mit Kud-Auflage / Tower head section with slewing ring support / Porte-flèche avec pivot / Testa porta-braccio / Cabeça de apoio de lança / Cabeza de torre</b>		6,68	1,70	1,96	3250
3	1	<b>Gegenausleger / Counter-jib</b> Contre-flèche / Contrabaccio Contra-lança / Contra-pluma		11,03	1,67	0,32	1260
4	1	<b>Ausleger-Anlenkstück / Jib heel section</b> Pied de flèche / Settore articolato di braccio Base articulada de lança / Pluma tramo primero		11,80	1,27	1,43	① 1360
5	1	<b>Ausleger-Zwischenstück / Intermediate jib section</b> Élément intermédiaire de flèche / Spezzone di braccio Peça suplementar da lança / Tramo intermedio pluma		11,84 11,81 5,20 10,20	1,17 1,17 1,17 1,17	1,39 1,47 1,36 1,36	Ⓒ 990 Ⓒ 800 Ⓒ 240 Ⓒ 390
6	1	<b>Ausleger-Kopfstück / Jib head</b> Pointe de flèche / Punta freccia Cabeça de lança / Tramo punta de pluma		1,17	1,27	0,42	Ⓒ 50
7	1	<b>Podeste / Platforms</b> Plates-formes / Plattaforma Plataforma / Plataforma		1,68	0,33	1,55	140
8	1	<b>Laufkatze / Trolley</b> Chariot / Carrello Carrinho / Carrito		1,57	1,35	0,77	135
9	1	<b>Unterflasche / Bottom</b> Moufle / Bozzello Gancha / Potipasto		0,88	0,25	0,97	150
10	1	<b>Hubwerk / Winch</b> Treuil / Argano / Mecanismo elevatoria Mecanismo elevación carga		1,52	1,36	0,72	630
<b>Turm</b>		<b>Tower / Mât / Torre</b> Torre / Torre					
11	1	<b>Grundturmstück / Base tower section</b> Mât de base / Elemento di torre base Tramo torre base / Peça de base de torre		11,7 m	11,88	1,23	3070
12	1	<b>Turmstück / Tower section</b> Élément de mât / Elemento di torre Torre / Torre		11,7 m 7,8 m 3,9 m	11,87 11,87 4,07	1,22 1,22 1,22	2730 1880 1065
<b>Fundamentkreuz</b>		<b>Cruciform base / Châssis en croix / Carro della gru</b> Carro de guindaste / Base cruciforme					
13	1	<b>Tragholm I / Arm I</b> Longeron I / Longherone I Travessa I / Brazo I		5,68	0,78	0,92	1710
14	1	<b>Tragholm II / Arm II</b> Longeron II / Longherone II Travessa II / Brazo II		5,68	0,71	1,09	1930
15	2	<b>Fahrschemel mit Antrieb / Rail bogie with drive</b> Bogie moteur / Telaio con gruppo propulsore Quadro sem grupo de propulsão / Caja rodillo motriz		1,08	0,54	0,63	510
16	2	<b>Fahrschemel ohne Antrieb / Rail bogie without drive</b> Bogie fou / Telaio senza gruppo propulsore Quadro com grupo de propulsão / Caja rodillo conducido		1,08	0,28	0,61	420
17	1	<b>Seile und Kleinteile / Small parts and ropes</b> Accessoire et câbles / Accessori cavi Accesorios e cabos / Accesorios y cables		-	-	-	2300

\* Einzelgewichte. / Single weights. / Poids individuels. / Pesì di componenti. / Pesos de peças componentes. / Pesos unitarios.

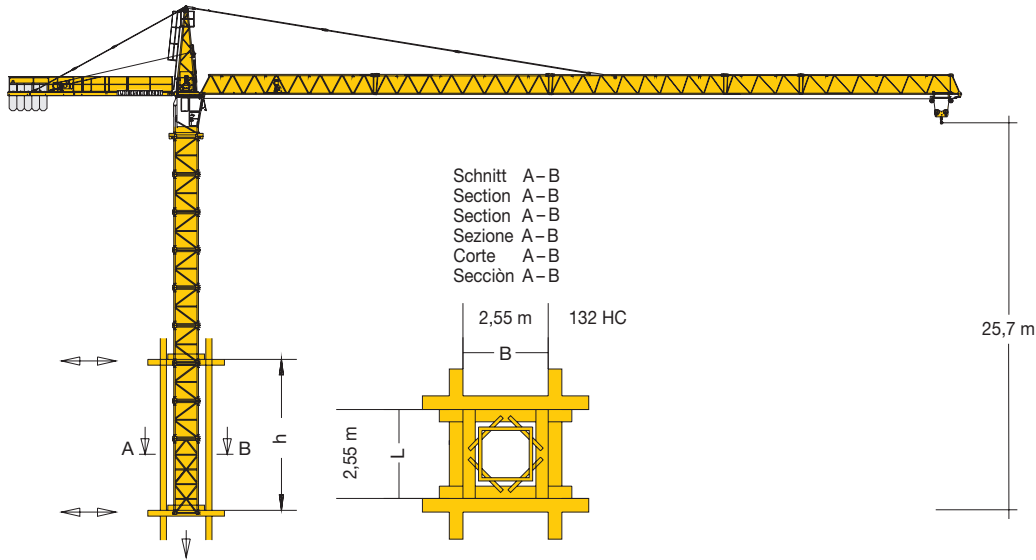

## Konstruktionsänderungen vorbehalten!

Subject to alterations! / Sous réserves de modifications!  
Si fa riserva di modifiche! / Salvo modificação da construação!  
¡Sujeto a modificaciones!

## Sämtliche Angaben erfolgen ohne Gewähr. / This information is supplied without liability.

Ces renseignements sont sans garantie. / Le indicazioni contenute si intendono salvo errori ed omissioni.  
Declinamos toda responsabilidad derivada de la información proporcionada. / Declinamos qualquer  
responsabilidade quanto à informação fornecida.